

Hall Effect Speed/ Proximity Sensor

Non-contact Hall effect sensor designed for speed or proximity measurements on critical turbomachinery applications such as steam, gas and hydro turbines, compressors, pumps, and fans.



Dynamic Performance	
Output	1 AC cycle per revolution/gear tooth
Rise/Fall Time	1 μ s
Output Voltage (12 VDC at 100 Kload)	High >10 V / Low <1V
Air Gap	1 mm (Module 1)
	1.5 mm (Module \geq 2)
Maximum Operating Frequency	12 kHz (720,000 cpm)
Trigger Mark Limited to	Spur Wheel, Involute Gearing Module 1
	Material ST37
Measuring Target	
Target/Surface Material	Magnetic soft iron or steel (non stainless steel)
Environmental	
Reference Temperature	25°C (77°F)
Operating Temperature Range	-25 to 100°C (-13 to 212°F)
Storage Temperature	-40 to 100°C (-40 to 212°F)
Sealing Rating	IP67
Power Supply	10 to 30 VDC @ max. 25mA
Resistance	Max. 400 Ohms
Material	Sensor – Stainless steel; Cable - PTFE
Weight (Sensor only)	210 grams (7.4 oz)

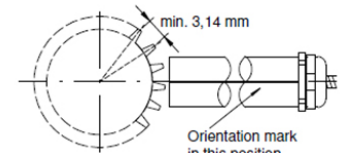

Fig. 1 Accurate mounting position

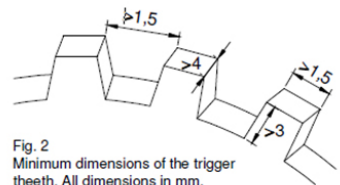

Fig. 2 Minimum dimensions of the trigger teeth. All dimensions in mm.

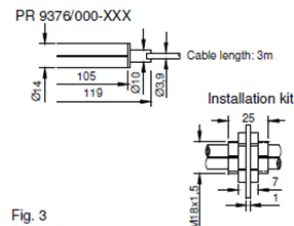
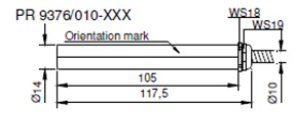

Fig. 3 Dimensions All dimensions in mm

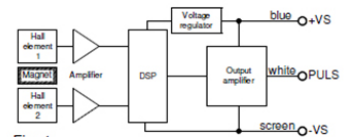
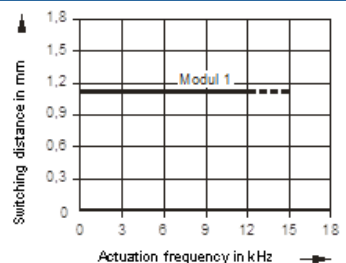

Fig. 4 Circuit diagram



Compliance and Certifications								
CE		2014/30/EU 2014/35/EU 2011/65/EU EN 60947-5-2 DIN EN 50581						
Ordering Information Sensor								
Model No.	/	0	Armored Cable X	0	-	0	Cable Length X	1
PR9376			0 Without 1 With				0 3m 1 5m 2 10m	

Example: PR9376/000-001

PR9376 sensor with 3 meter non-armored cable, Open Cable End

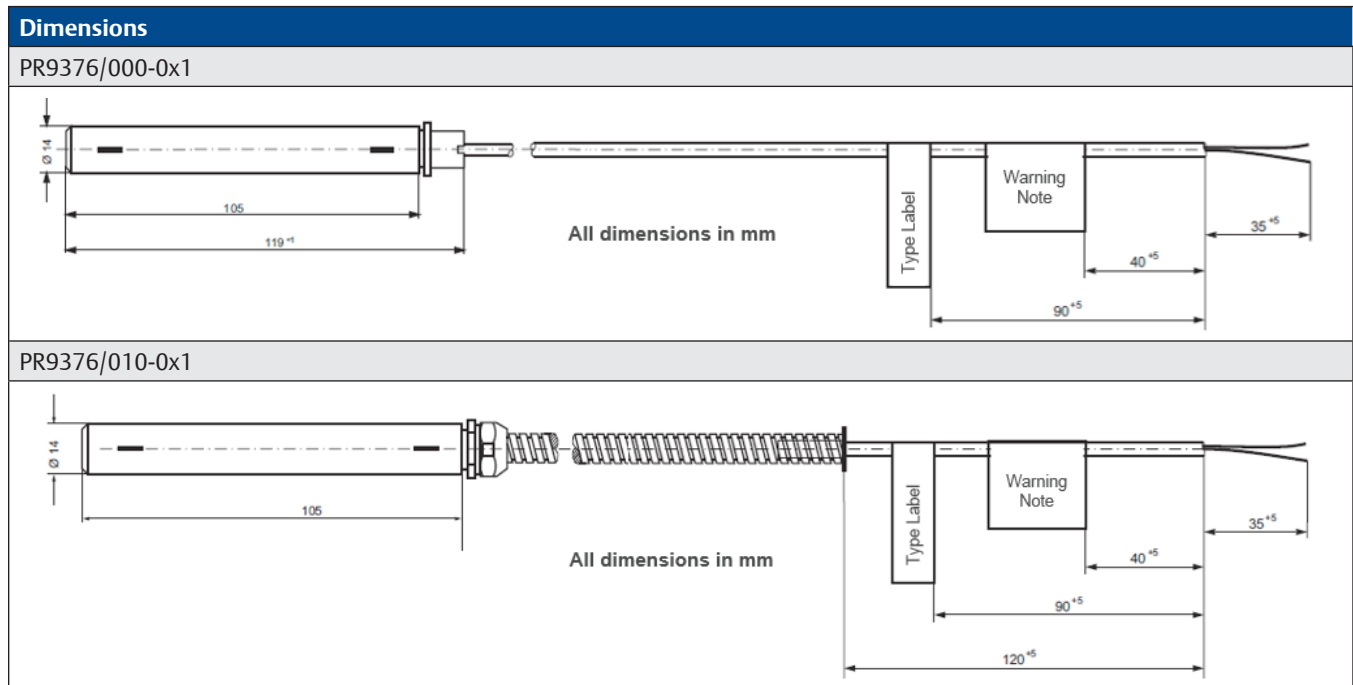

Emerson
Reliability Solutions
835 Innovation Drive
Knoxville, TN 37932 USA
☎ +1 865 675 2400

🌐 www.emerson.com/ams

©2018, Emerson. All rights reserved.

The Emerson logo is a trademark and service mark of Emerson Electric Co. The AMS logo is a mark of one of the Emerson family of companies. All other marks are the property of their respective owners.

The contents of this publication are presented for informational purposes only, and while diligent efforts were made to ensure their accuracy, they are not to be construed as warranties or guarantees, express or implied, regarding the products or services described herein or their use or applicability. All sales are governed by our terms and conditions, which are available on request. We reserve the right to modify or improve the designs or specifications of our products at any time without notice.